

**CITY OF FARGO SPECIFICATIONS  
SIGNING**

**PART 1  
DESCRIPTION OF WORK**

The work to be done under this section of the Specifications and the accompanying plans consists of furnishing all labor, material and accessories necessary to complete the installation of signage in the City of Fargo.

**PART 2**  
**MATERIALS**

All materials furnished and used for this project shall be new and shall meet the City of Fargo Details. The traffic control sign details not otherwise specified shall meet the current edition of the Manual of Uniform Traffic Control Devices, published by the FHWA. All sign faces shall be according to the detail drawings and the alphabets shown in the MUTCD, Standard Highway Signs, and Standard Alphabets, published by FHWA.

2.1. FLAT SHEET ALUMINUM

Flat sheet aluminum shall be an alloy meeting ASTM B 209 Alloy 6061 T6, or 5052-H38 with mill finish.

2.2. HARDWARE AND FITTINGS

*2.2.1 Post Mounting Hardware*

All steel bolts, nuts, U-bolts, lock washers, and washers shall be galvanized steel meeting ASTM A153.

*1. Bolts*

Steel panel bolts, machine bolts, etc., shall meet SAE J429 Grade 5 or ASTM A449.

*2. Nuts*

Steel hex nuts shall meet SAE J995 Grade 5 or ASTM A563.

*3. Washers*

Steel flat washers shall be fabricated of steel meeting ASTM F844. Plastic washers shall be fabricated to the sheeting manufacturer's specifications.

*2.2.2. Light Standard Mounting Hardware*

1. *Bolts*

Stainless Steel hex bolts, 1/4" diameter

2. *Self-Tapping Screws*

1/4" Self Tapping Screws with hex head and locking flange

3. *Washers*

Steel flat washers shall be fabricated of steel meeting ASTM F844. Plastic washers shall be fabricated to the sheeting manufacturer's specifications.

2.3. POSTS

Posts shall be Telespar 12 gauge brand.

## **PART 3 CONSTRUCTION**

### 3.1. PRE-CONSTRUCTION SIGN RECONNAISSANCE

All existing sign posts shall be assumed to be straight and in good condition. The Contractor should verify all signage within the project limits is straight and in good condition. Before starting work, the Contractor will provide the project Engineer with a list of any damaged posts or signs. Upon substantial completion of the contract, the signs that were not on the list provided by the Contractor pre-construction but were damaged during the construction activity will be assumed to have been damaged by the Contractor and is his responsibility to replace any damaged signs to City of Fargo Standards and Specifications.

The Contractor has the responsibility of protecting all existing street signs and their supports from damage during the course of this project. The Contractor will replace and install with new all damaged signs and their supports at their own expense. In the event that they are temporarily removed during the project the City of Fargo will provide locations for them to be replaced in their original location.

### 3.2. LOCATING AND POSITIONING SIGNS

Each sign shall be located according to the plans. Installed signs will be inspected at night for maximum effect. If any sign is ineffective at night, the sign shall be replaced at the Contractor's expense.

### 3.3. SIGN FABRICATION, PACKAGING, LABELING, HANDLING, AND SHIPPING

All sign fabrication, packaging, labeling, handling, and shipping shall follow the latest version of the NDDOT Standard Specifications for Road and Bridge Construction.

### 3.4. ANCHOR FOR TELESCOPING PERFORATED TUBES SUPPORTS

#### *3.4.1. Boulevard Sign Placement (Detail 5.2)*

Anchors and Anchor Sleeves for telescoping perforated tubes supports shall be driven. The perforated tube anchor and sleeve shall be driven to a height of 5-6 inches above the ground. Anchors and Sleeves shall be installed per detail. Telescoping Tube posts will

not be a pay item; it will be incidental to the “Sign Assembly” bid items. It is the Contractor’s responsibility to install the sign assembly to the required height.

*3.4.2. Concrete or Asphalt Sign Placement (Detail 5.3)*

Anchors and Anchor Sleeves for telescoping perforated tubes supports shall be driven. The perforated tube anchor and sleeve shall be driven to a maximum of 5-6 inches above the sidewalk or asphalt surface. Anchors and Sleeves shall be installed per detail. If the sidewalk is installed prior to sign installation, it shall be cored to install the anchor and sleeve unit and the cored area shall be filled with pea rock to restore the sidewalk surface. If the sign is existing and the sidewalk is being poured around an existing base, a sleeve of 4 inch diameter shall be used around the base to prevent concrete from contacting the sign post. Telescoping Tube posts will not be a pay item; it will be incidental to other “Sign Assembly” bid items. It is the Contractor’s responsibility to install the sign assembly to the required height.

3.5. MOUNTING FLAT SHEET SIGNS

Flat sheet signs shall be bolted to the post or light standard, and shall have a nylon washer between the flat washer and the sign face.

3.6. REMOVING AND RESETTING SIGNS AND SIGN ASSEMBLIES

Existing signs and sign assemblies shall be removed or reset as specified. All signs and sign assemblies not to be reset shall be defaced and shall become property of the Contractor and Contractor shall be responsible for discarding items. Removed or reset signs and sign assemblies that become damaged during removing, resetting, or stockpiling shall be replaced at the Contractor’s expense. Existing signs and sign assemblies shall be removed as construction progresses, and shall be immediately reset or installed. The Contractor shall install new signs or reset signs as shown on the Plans. Any damaged signs or sign assemblies shall be replaced at the Contractor’s expense.

3.7. BREAKAWAY BASES

Breakaway bases for telescoping tubes will not be allowed on any City of Fargo construction projects.

## **PART 4**

### **GUARANTEE, MEASUREMENT & PAYMENT**

#### 4.1. GUARANTEE

The guarantee shall be per the contract.

#### 4.2. MEASUREMENT & PAYMENT

##### *4.2.1. SIGN PANELS*

Flat sheets and panels will be paid to the closest 1/10 square foot, based on the largest measurement, horizontally and vertically as set forth in the latest edition of the Standard Highway Signs Manual published by the FHWA. All hardware, stringers, and brackets required to attach signs to the posts shall be included in the pay item.

##### 4.2.1.1. EG Signs

This item shall be paid for at the contract unit price per square foot and shall include the cost to supply "Engineering Grade" sheeting and aluminum panel. The size of each sign shall be as shown on the plans.

##### 4.2.1.2. HIP Signs

This item shall be paid for at the contract unit price per square foot and shall include the cost to supply "High Intensity Prismatic" sheeting and aluminum panel. The size of each sign shall be as shown on the plans.

##### 4.2.1.3. DG3 Signs

This item shall be paid for at the contract unit price per square foot and shall include the cost to supply "DG Cubed" sheeting and aluminum panel. The size of each sign shall be as shown on the plans.

##### *4.2.2. INSTALL SIGN ASSEMBLY (POST)*

This item shall be paid for at the contract unit price per each, and shall include the cost to supply and install the sign support, reinforcement sleeve, and soil anchor in accordance

with the detailed drawings. The post and anchor shall be manufactured of Telespar 12 gauge square perforated tube of the size shown on the detail. The Contractor shall verify the proper length required to provide the required vertical clearance.

#### *4.3. INSTALL SIGN ASSEMBLY (LIGHT STANDARD)*

This item shall be paid for at the contract unit price per each, and shall include the cost to supply and install the sign hardware and banding material for the mounting of signs on new or existing light standards.

#### *4.4. INSTALL TYPE III BARRICADE*

This item shall be paid for at the contract unit price per each, and shall include the cost to supply and install (2) sign supports, (2) reinforcement sleeves, and (2) soil anchors in accordance with the detailed drawings. The post and anchor shall be manufactured of Telespar 12 gauge square perforated tube of the size shown on the detail. The Type III Barricade Rail is incidental to the installation of the Type III Barricade. Any sign mounted on the Type III Barricade shall be paid in accordance with section 4.2.1. The Contractor shall verify the proper length required to provide the required vertical clearance.

#### *4.5. RELOCATE SIGN ASSEMBLY*

This item shall be paid for at the contract unit price per each, and be measured by the number of locations at which a sign assembly has been reset. A sign assembly consists of the sign, post, sleeve, anchor and mounting hardware for post mounted signs. A sign assembly consists of mounting hardware and sign face for light standard mounted signs. Signs and assemblies will be counted in place and accepted by the Engineer.

#### *4.6. REMOVE SIGN ASSEMBLY*

Removed signs and sign assemblies will not be measured for payment as they are incidental to the project.

*4.7. OTHER COSTS*

All other costs for work necessary to properly complete the work specified herein shall not be bid items; the costs shall be charged to other items unless a bid item is specifically included on the bid sheet.



VERTICAL CLEARANCE
7' FOR SINGLE SIGN
6' FOR DOUBLE SIGN

SIGN SIZE	SIGN THICKNESS
≤ 24" (& 30" STOP SIGNS)	80 GA.
> 24" (EXCEPT 30" STOP SIGNS)	100 GA.

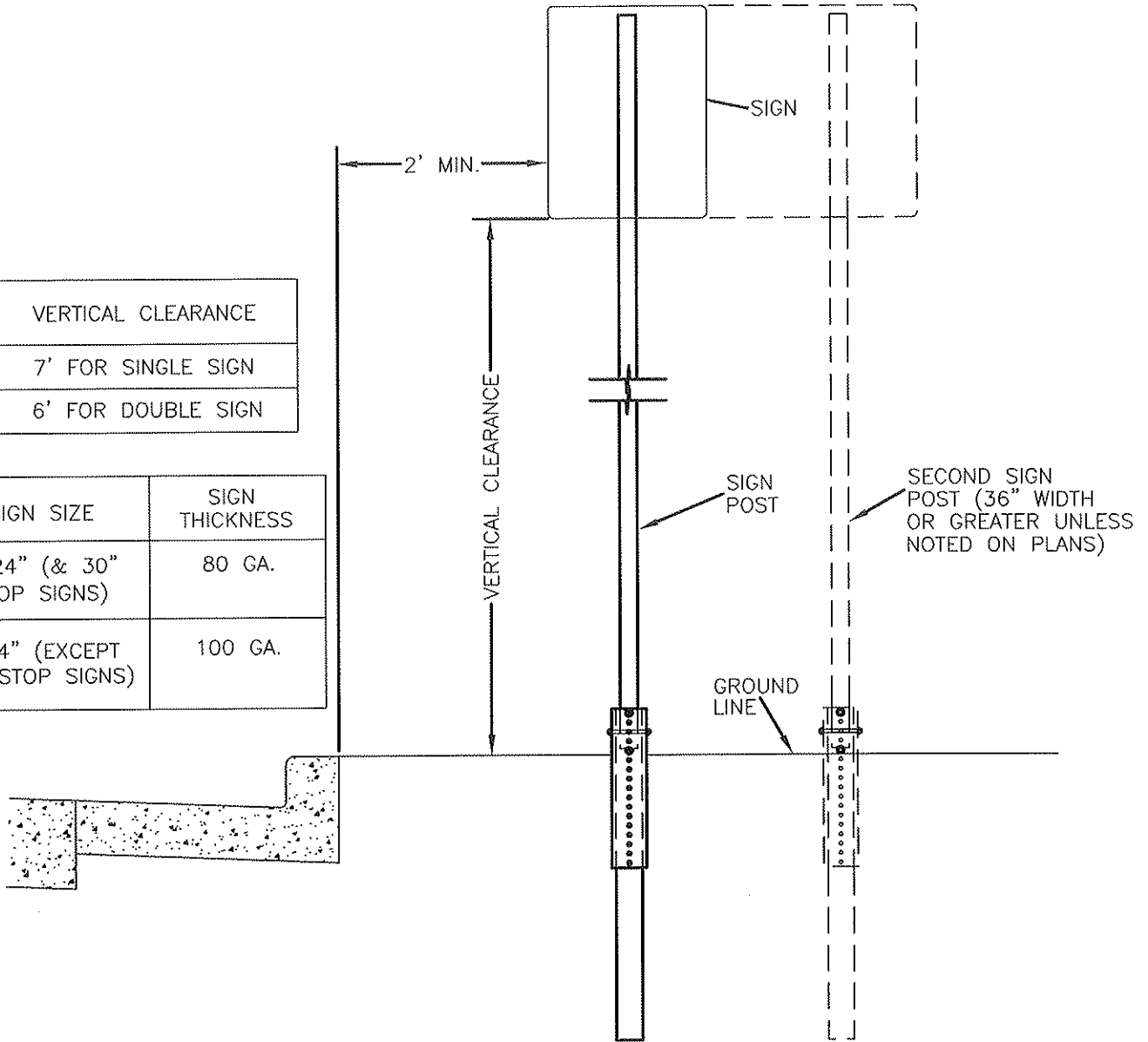

DATED SIGN TAGS ALL NEW SIGNS THAT ARE INSTALLED SHALL HAVE A DATED TAG INSTALLED ON THE BACK OF THE SIGN, SHOWING THE CONTRACTORS LOGO, MONTH AND THE YEAR THAT THE SIGN WAS INSTALLED. THE DATE SHALL BE SHOWN BY REMOVING THE CORRECT MONTH AND YEAR WITH A HOLE PUNCHER. THIS SHALL BE INCIDENTAL TO THE COST OF THE SIGN.

SECTION NO. 4300	DRAWING NO. 5.1
REV, D.	
<b><i>SIGN ASSEMBLY</i></b>	
CITY OF FARGO ENGINEERING DEPARTMENT	
APPROVED JAD	DATE 1/2/2013

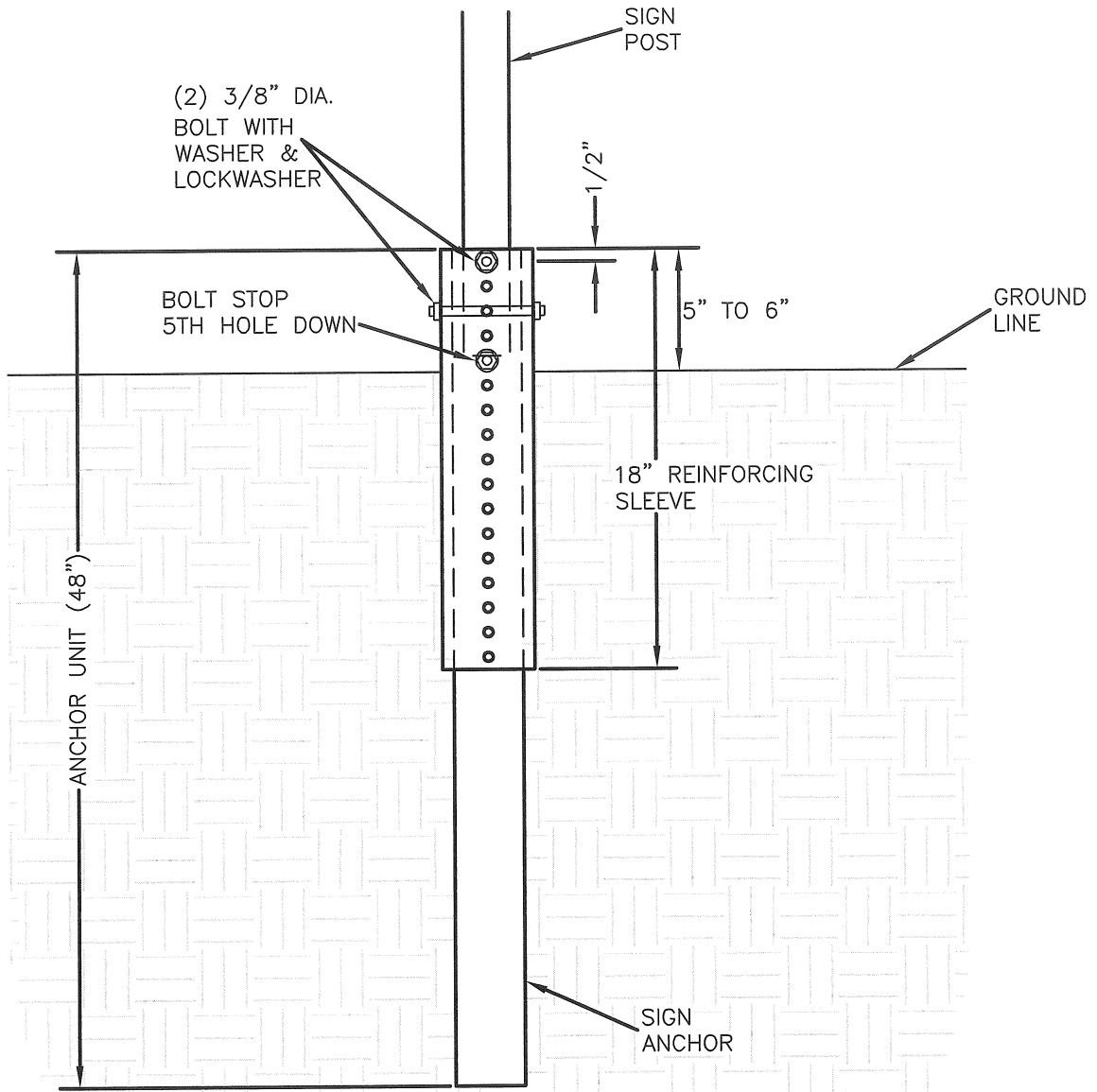

NOTE: REINFORCING SLEEVE TO BE USED ON ALL SIGNS

SIGN SIZE	POST	ANCHOR	SLEEVE
12" WIDTH SIGNS	1.50"	1.75"	2.00"
18" WIDTH SIGNS & 24"x24" SIGNS	1.75"	2.00"	2.25"
LARGER THAN 24"x24"	2.00"	2.25"	2.50"

SECTION NO. 4300	DRAWING NO. 5.2
REV.D.	
<b>SIGN ANCHOR BLVD INSTALLATION</b>	
CITY OF FARGO ENGINEERING DEPARTMENT	
APPROVED <i>BEO</i>	DATE <i>2-21-2012</i>

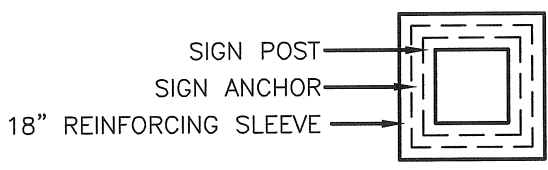
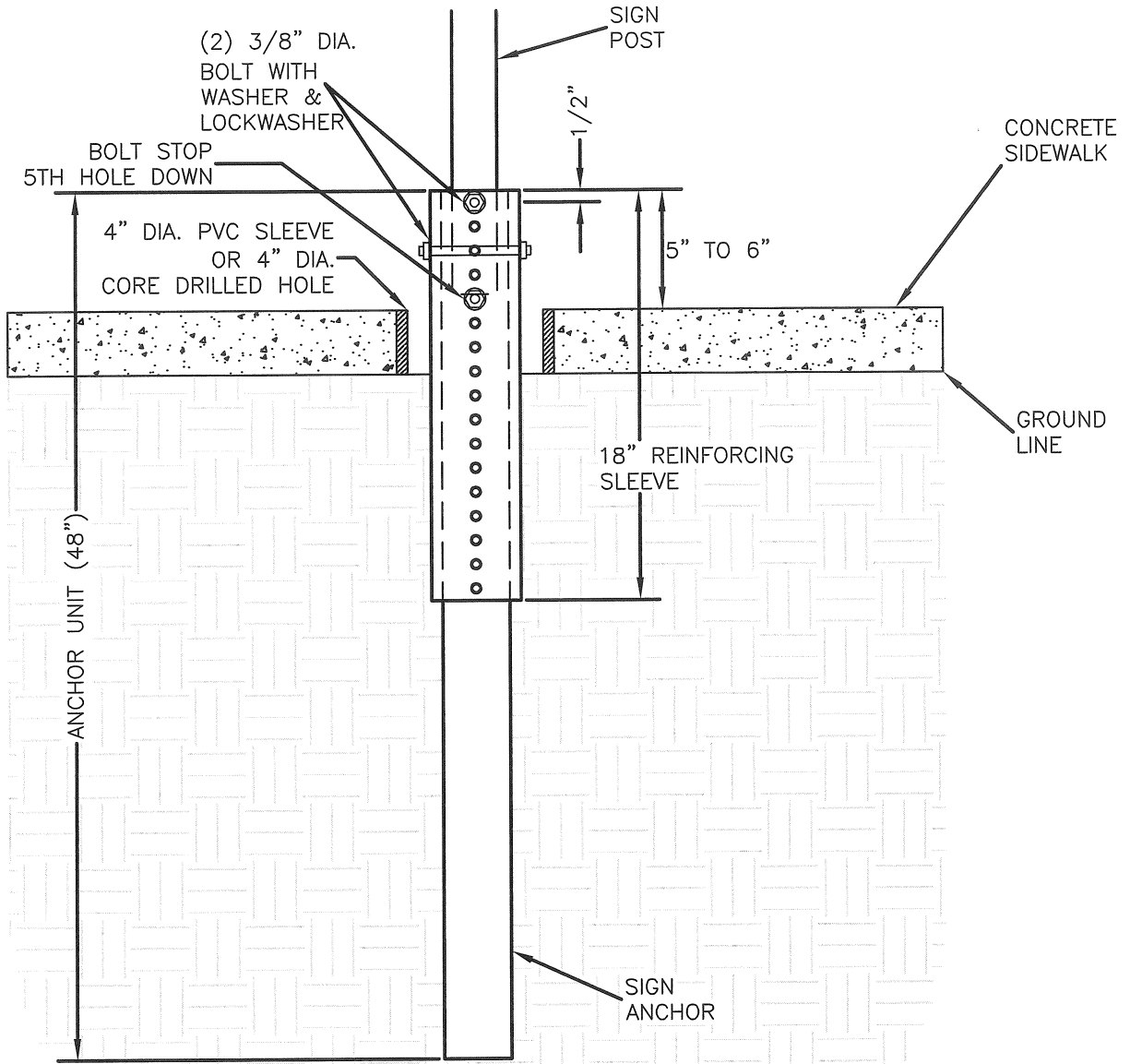

NOTE: REINFORCING SLEEVE TO BE USED ON ALL SIGNS

SIGN SIZE	POST	ANCHOR	SLEEVE
12" WIDTH SIGNS	1.50"	1.75"	2.00"
18" WIDTH SIGNS & 24"x24" SIGNS	1.75"	2.00"	2.25"
LARGER THAN 24"x24"	2.00"	2.25"	2.50"

SECTION NO. 4300	DRAWING NO. 5.3
REV,D.	
<b>SIGN ANCHOR SIDEWALK INSTALLATION</b>	
CITY OF FARGO ENGINEERING DEPARTMENT	
APPROVED <i>BED</i>	DATE <i>2-21-2012</i>

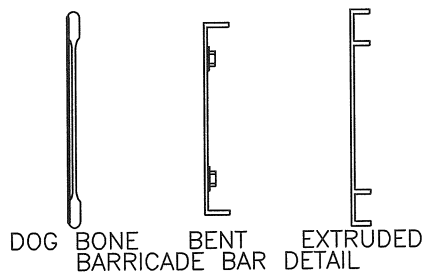
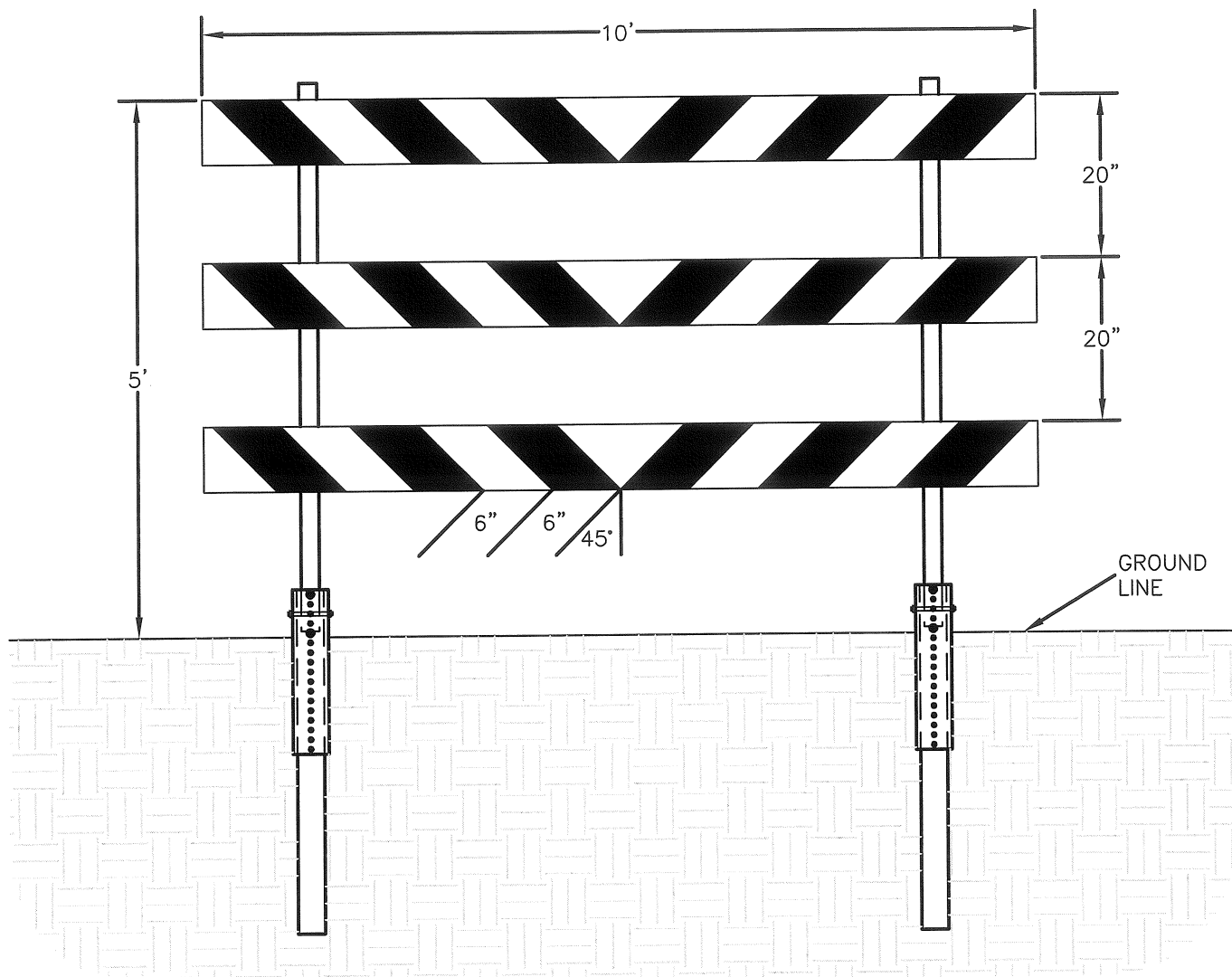

BARRICADE RAILS SHALL BE 8" OR 9" X 120".  
 SHEETING MATERIAL SHALL BE DG3 SHEETING, ALTERNATING RED AND WHITE AT A 45° ANGLE.  
 TYPE III BARRICADE SHALL CONFORM TO THE LATEST EDITION OF THE MUTCD.

SECTION NO. 4300	DRAWING NO. 5.4
REV.D.	
<b>TYPE III BARRICADE</b>	
CITY OF FARGO ENGINEERING DEPARTMENT	
APPROVED <i>BEO</i>	DATE <i>2-21-2012</i>

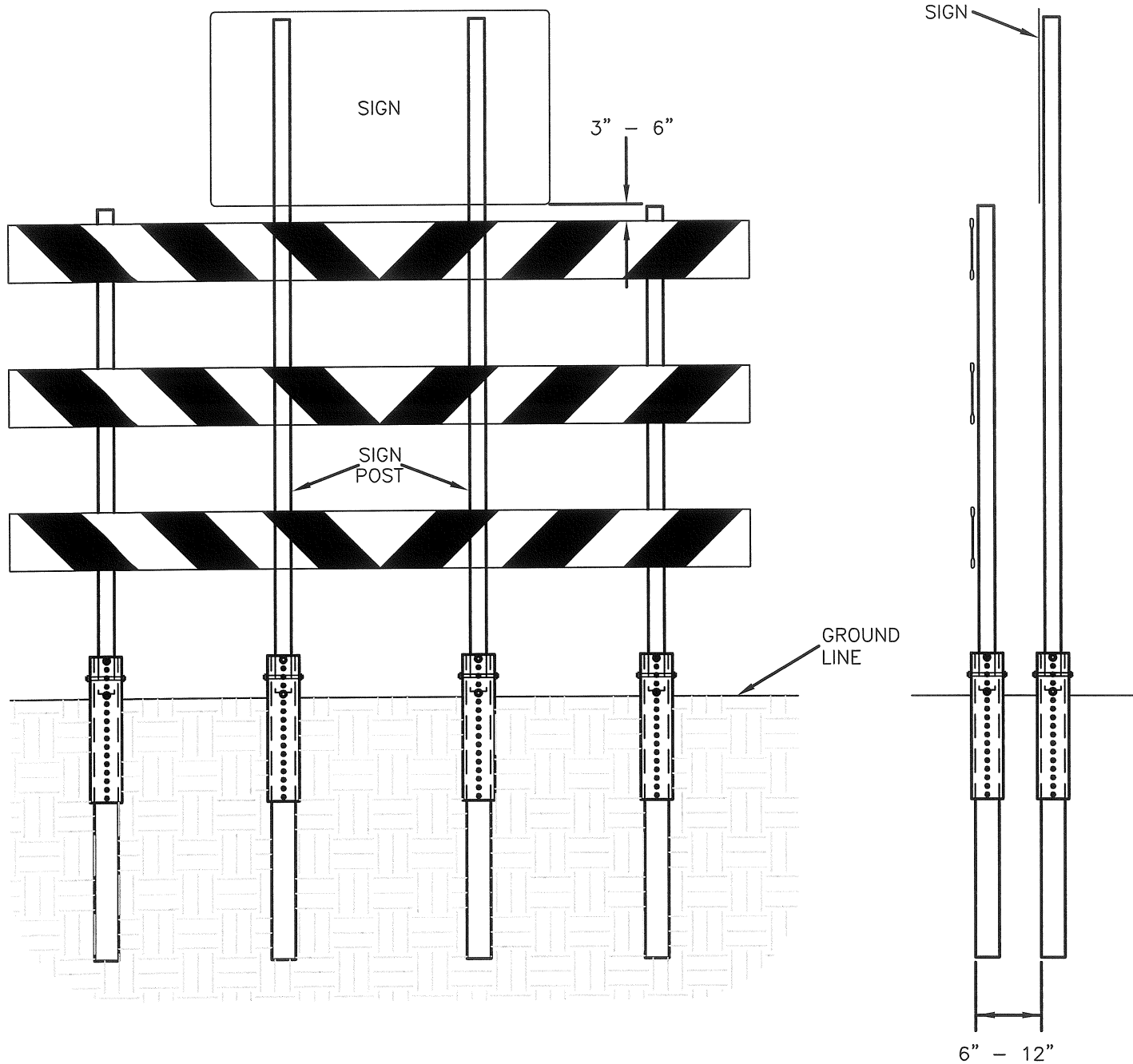

SECTION NO. 4300	DRAWING NO. 5.5
REV. D.	
<b>SIGN ADJACENT TO BARRICADE</b>	
CITY OF FARGO ENGINEERING DEPARTMENT	
APPROVED <i>BED</i>	DATE <i>2-21-2012</i>

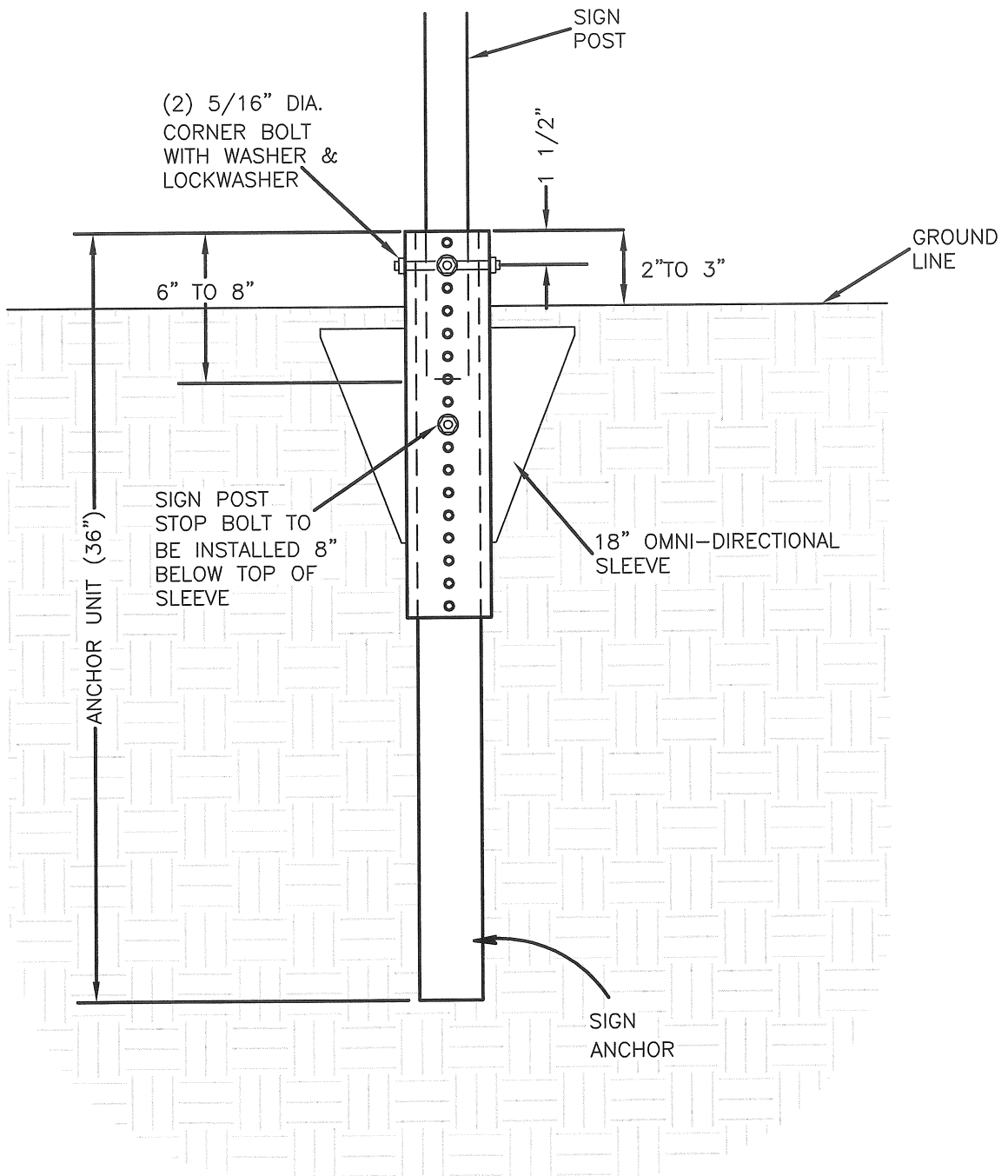

NOTE: OMNI-DIRECTIONAL SLEEVE W/4 BLADES TO BE USED ON STREET DESIGNATION SIGNS

SECTION NO. 4300	DRAWING NO. 5.6
REV. D.	
<b><i>STREET DESIGNATION ANCHOR INSTALLATION</i></b>	
CITY OF FARGO ENGINEERING DEPARTMENT	
APPROVED <i>BED</i>	DATE <i>2-21-2012</i>

STREET DESIGNATION SIGNS

All street designation signs shall utilize 9" 80 gauge flat aluminum, 24" or longer (in 3" increments), depending on the space needed.

The signs shall have 6" series "B" upper case letters with 4 1/2" lower case format and a 1/2" border.

The sign sheeting shall be 3M Series 4090 DG sheeting and any processed colors, inks, or electronic cuttable film shall be a matched component system. All Street Desig. Signs shall have a 9' clearance to bottom of sign. The following are examples of the sign format.

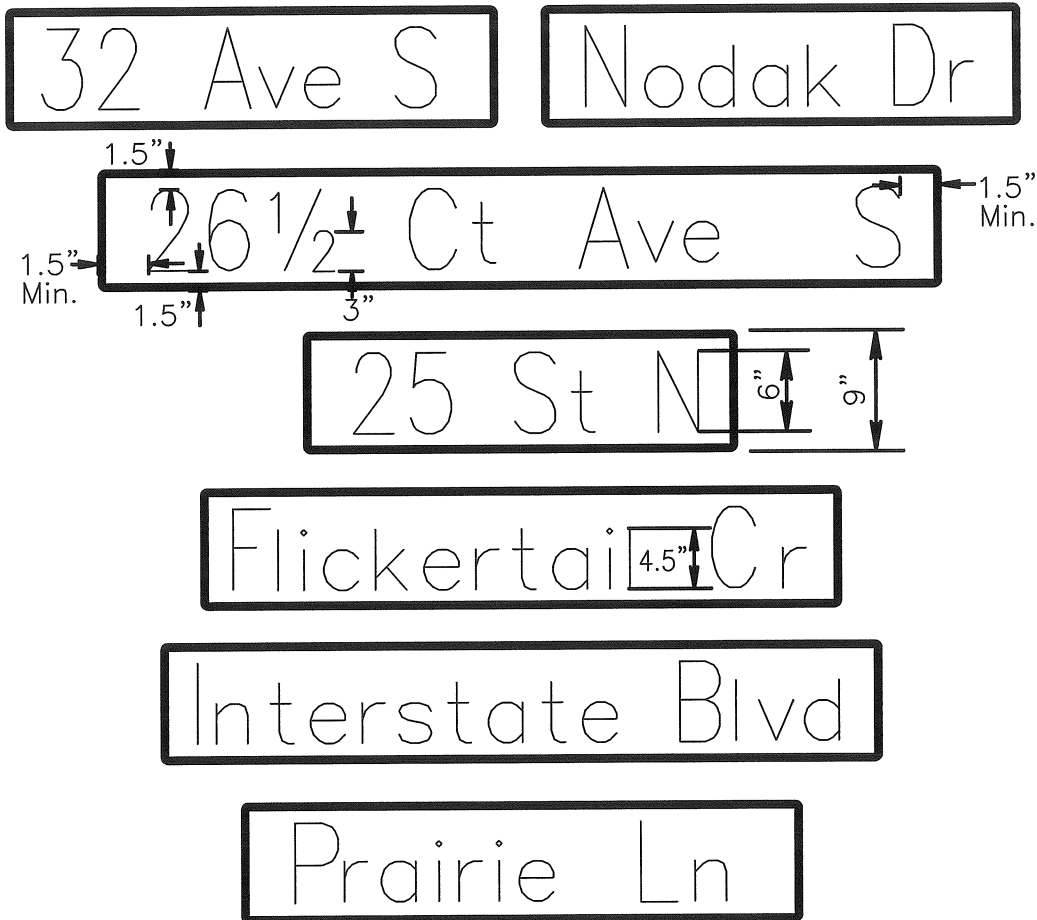

SECTION NO. 4300	DRAWING NO. 5.7
REV.D.	
<b>STREET DESIGNATION SIGN INSTALLATION</b>	
CITY OF FARGO ENGINEERING DEPARTMENT	
APPROVED <i>BED</i>	DATE <i>2-21-2012</i>

MAST ARM MOUNTED STREET DESIGNATION SIGNS

All mast arm mounted street designation signs shall utilize 18" 100 gauge flat aluminum, 48" or longer, depending on the space needed.

The signs shall have modified "E" series letters with a 12" upper and 9" lower case format and a 1" sign border.

The sign sheeting shall be 3M series 4090 DG sheeting, and any processed colors, inks, or electronic cuttable film shall be a matched component system.

The following are examples of the sign format.

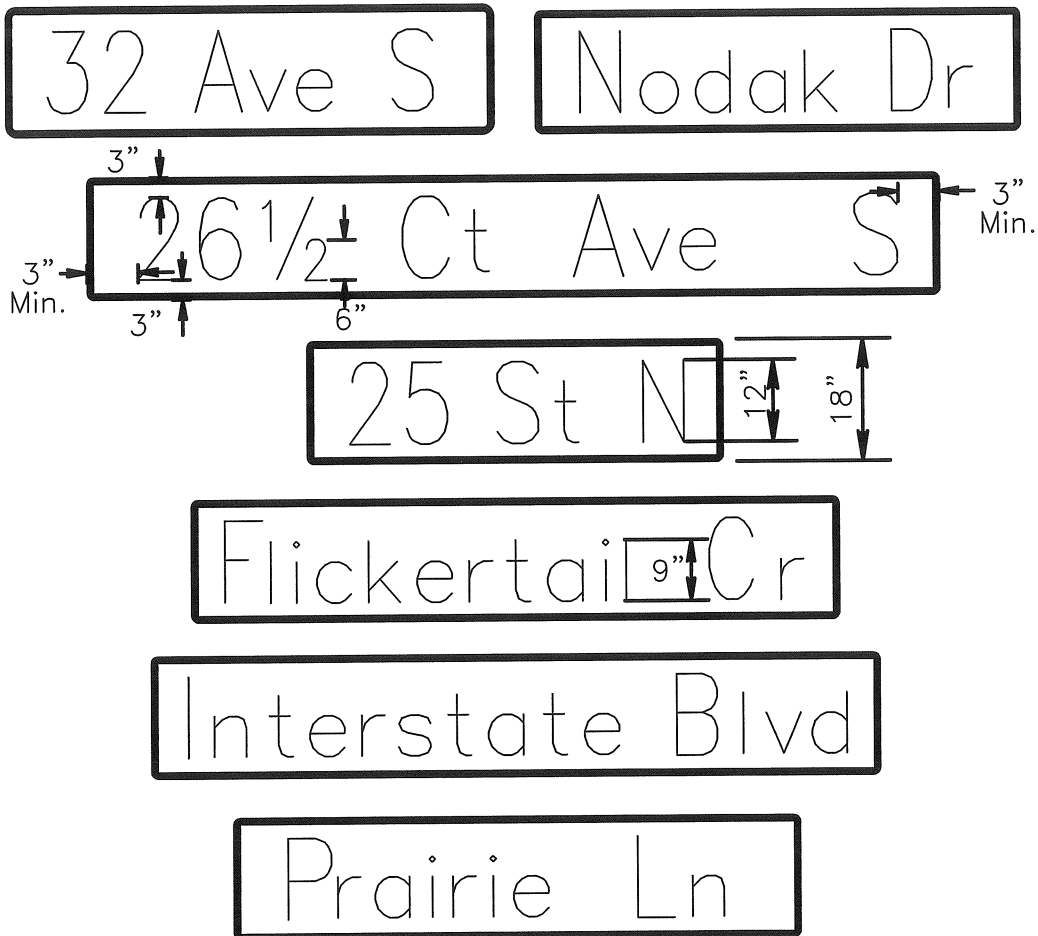

SECTION NO. 4300	DRAWING NO. 5.8
REV.D.	
<b><i>STREET DESIGNATION MAST ARM INSTALLATION</i></b>	
CITY OF FARGO ENGINEERING DEPARTMENT	
APPROVED <i>BED</i>	DATE <i>2-21-2012</i>